

SPIROTECH SPECIFICATION SHEET



Version 17.10 / BDB

Product: SpiroVent Hi-flow
DN 50 Flanged end

Type: HA050F

Customer: 1

Project: 2

Date: 2/26/2018

Reference: 3

Design criteria

Medium: Water / glycol (max 50%)
 Max. flow velocity: 3 m/s
 Max. flow rate: 7.0 l/s
 Max. pressure: 10 bar-g
 Max. temperature: 110 °C
 Δp at max. flow: 11.87 kPa
 Flow: 1.5 l/s
 Δp at flow: 0.55 kPa
 Design standard: EN 13445

Drawing:

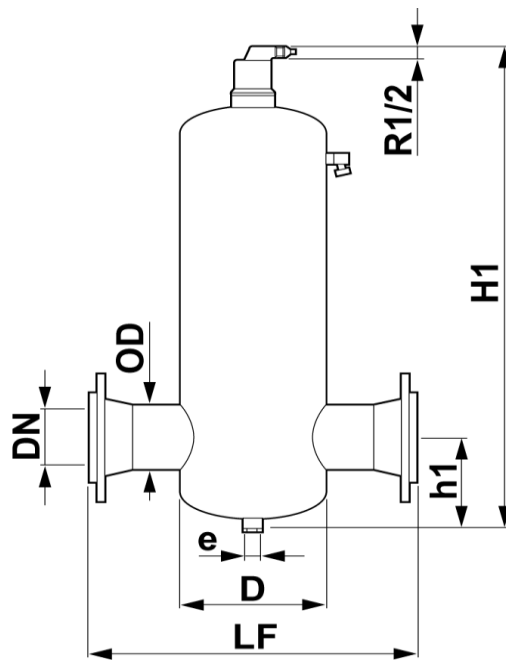

Testing and quality assurance

Test pressure (bar): 7
 Test medium: Air
 Test certificate: no
 Design and manufacturing acc. 2014/68/EU: yes
 Material certificates (structural parts): no
 Drawing: no
 Weld procedures: no
 Nondestructive Testing (X-ray: 10%): no
 Notified body inspection: no

Construction materials

Body: S235 JR G2 (St.37)
 Connections: S235 JR G2 (St.37)
 Fittings: S235 JR G2 (St.37)
 Flanges (EN 1092-1 PN16): C22.8
 Heads: S235 JR G2 (St.37)
 Deaeration cap: Brass
 Valve sealing: Viton
 Float: PP
 Spirotube Tube: S235 JR G2 (St.37)
 Wire: Copper
 Solder: Tin(SnCu3)
 Paint: Standard
 Color: Yellow (RAL 1003)

Dimensions:

DN	50	mm
OD	60.3	mm
H1	630	mm
h1	115	mm
D	159	mm
LF	350	mm
e	1/2"	

Volume: 7 ltr
 Dry weight (approx): 17 kg

Subject to changes